







 Ø6,3x50 mm <b>A1 x 30</b>	 Ø12 mm <b>A2 x 30</b>	 4 mm <b>A3 x 1</b>	 Ø15x12 mm <b>B1 x 8</b>	 Ø5x44 mm <b>B2 x 8</b>
 Ø20 mm <b>B3 x 8</b>	 Ø4x16 mm <b>D1 x 16</b>	 Ø3x25 mm <b>D2 x 8</b>	 Ø1,6x25 mm <b>F x 76</b>	 Ø8x36 mm <b>G x 16</b>
 <b>M x 4</b>	 Ø15 mm <b>N x 8</b>	 <b>Z x 8</b>		

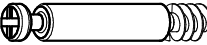

### Box 1 / 2

1600x400x16 mm

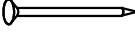
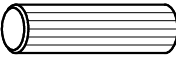
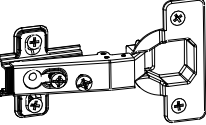

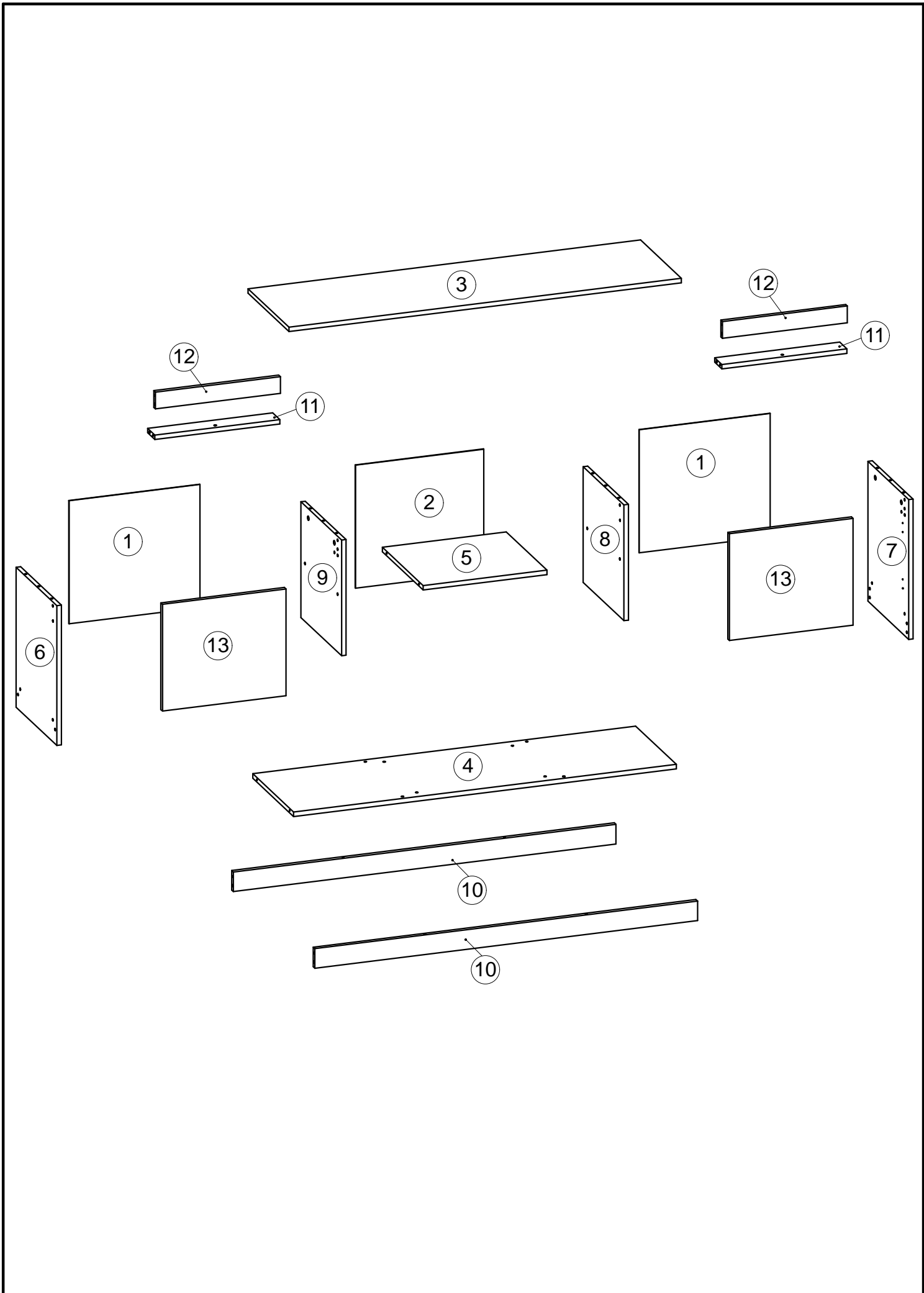
1566x399x16 mm



510x399x16 mm

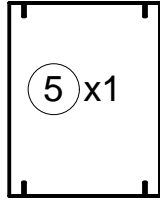

499x399x16 mm

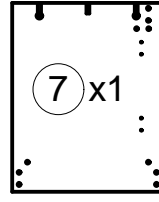

1566x70x16 mm

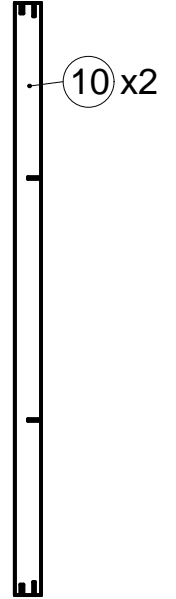

499x399x16 mm

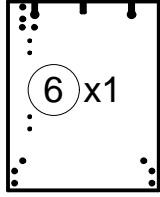

413x399x16 mm

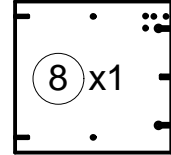

413x399x16 mm

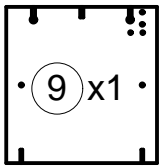

512x70x16 mm

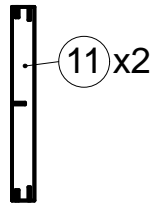

512x60x16 mm

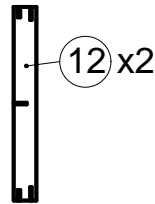

Fittings & Tools

### Box 2 / 2

533x439x3 mm

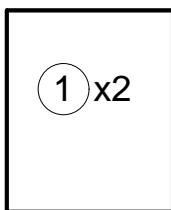

526x439x3 mm

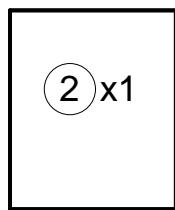

506x380x16 mm

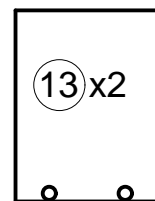

1

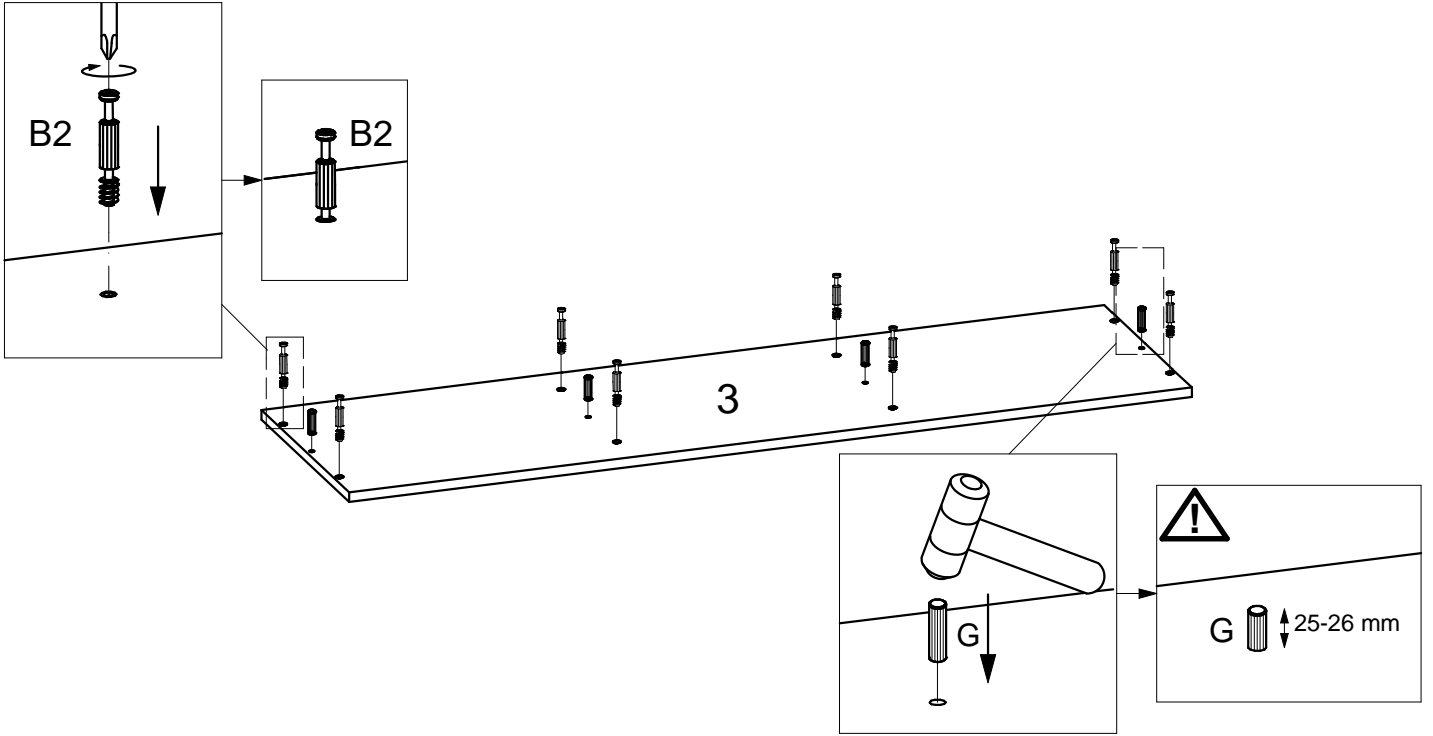
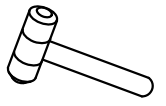
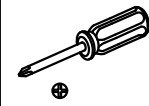
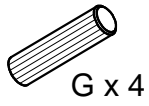
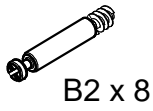

2

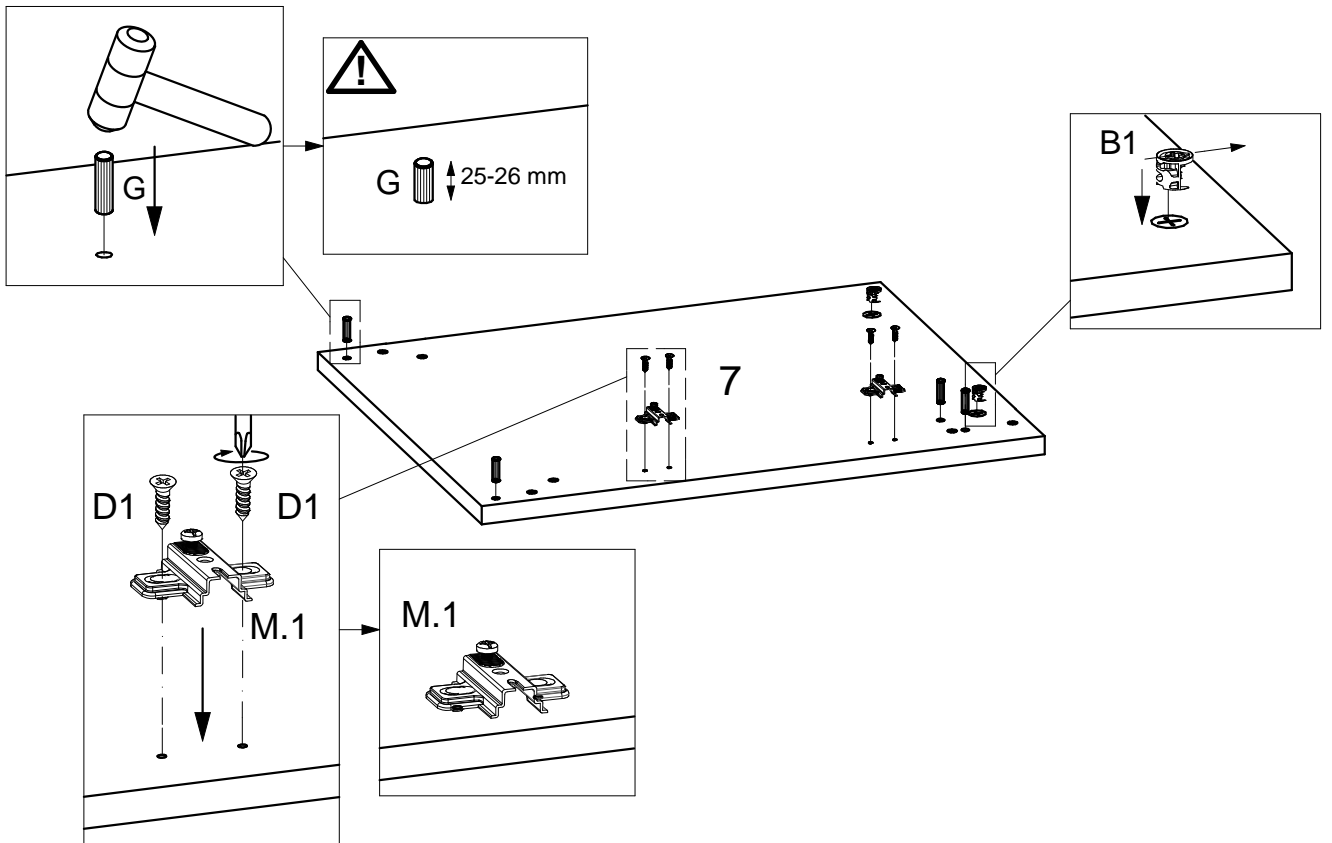
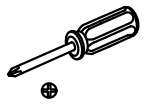
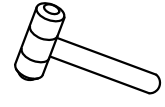

3



B1 x 2



G x 2

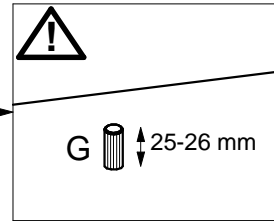
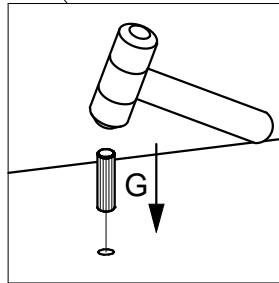
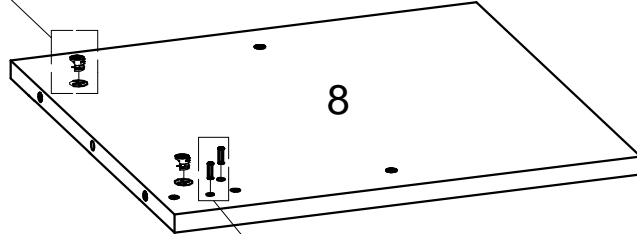
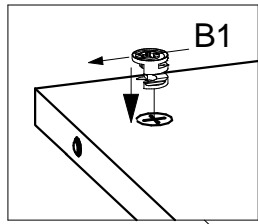
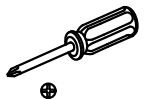
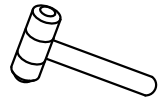

4



B1 x 2



G x 2

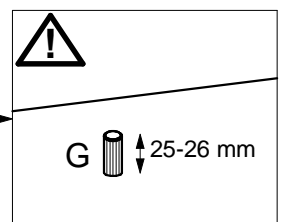
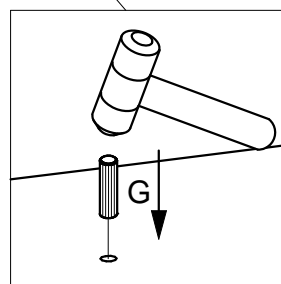
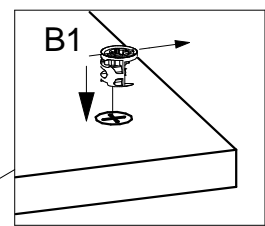
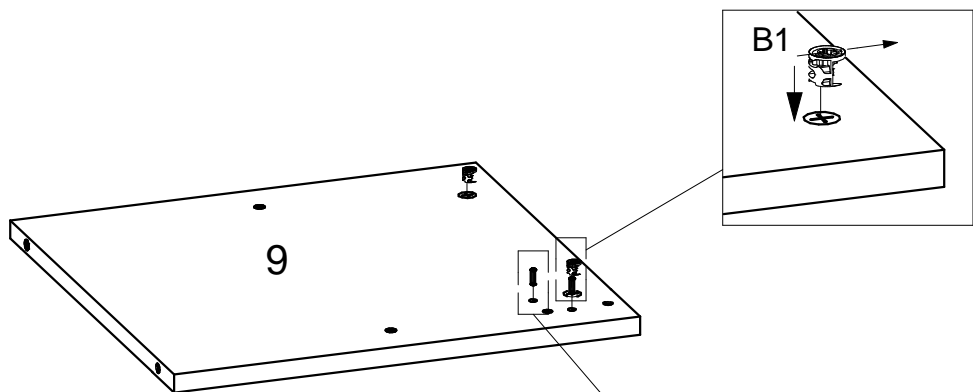
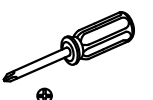
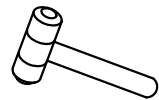

5

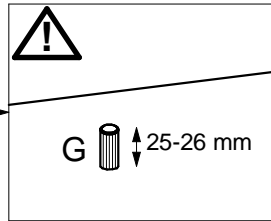
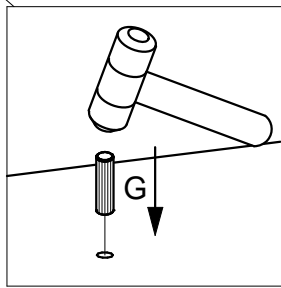
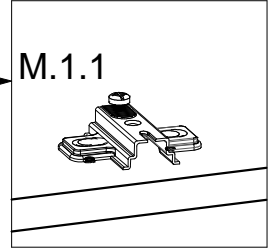
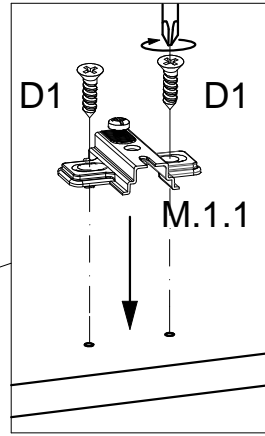
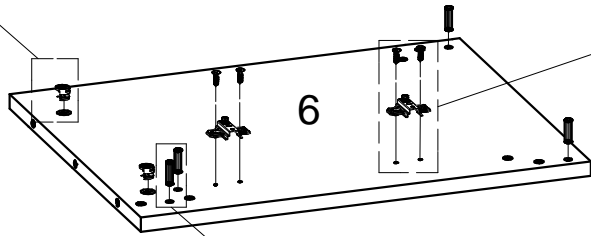
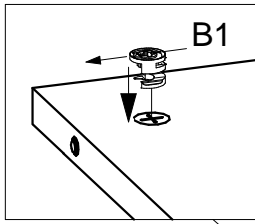
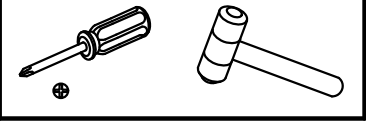
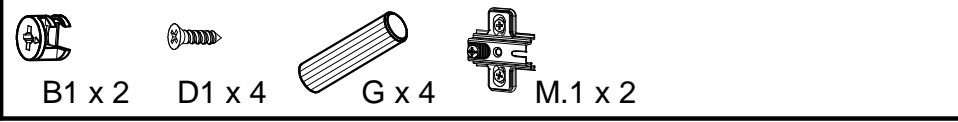

6

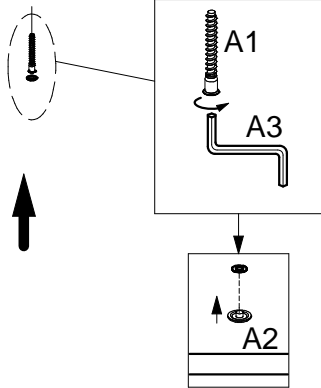
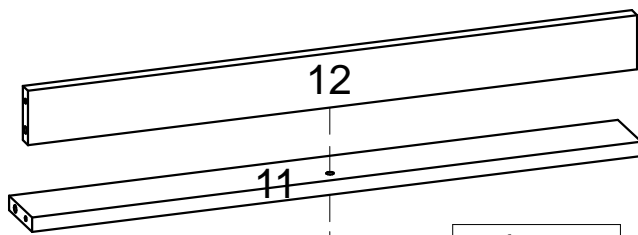
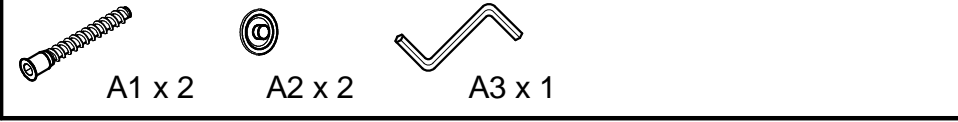

x 2



7

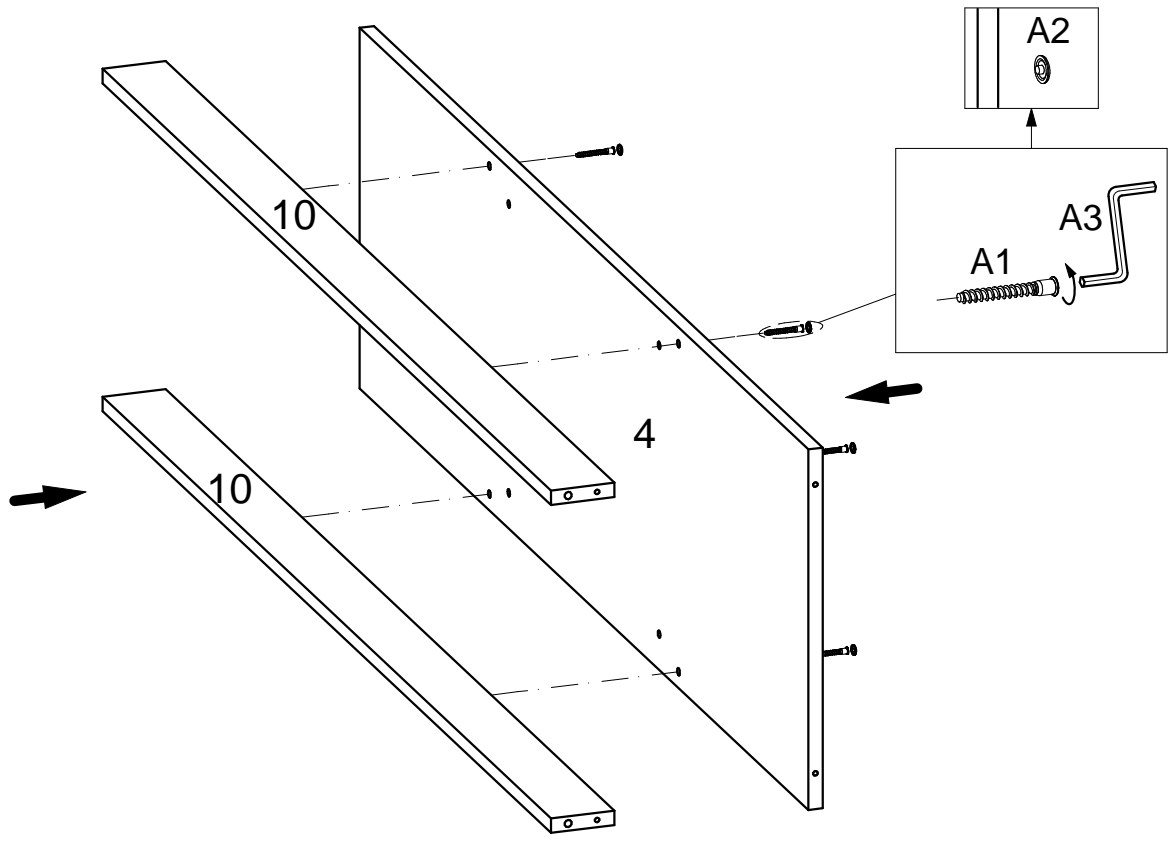
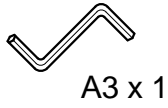
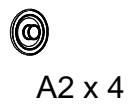
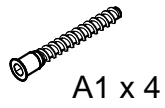

8

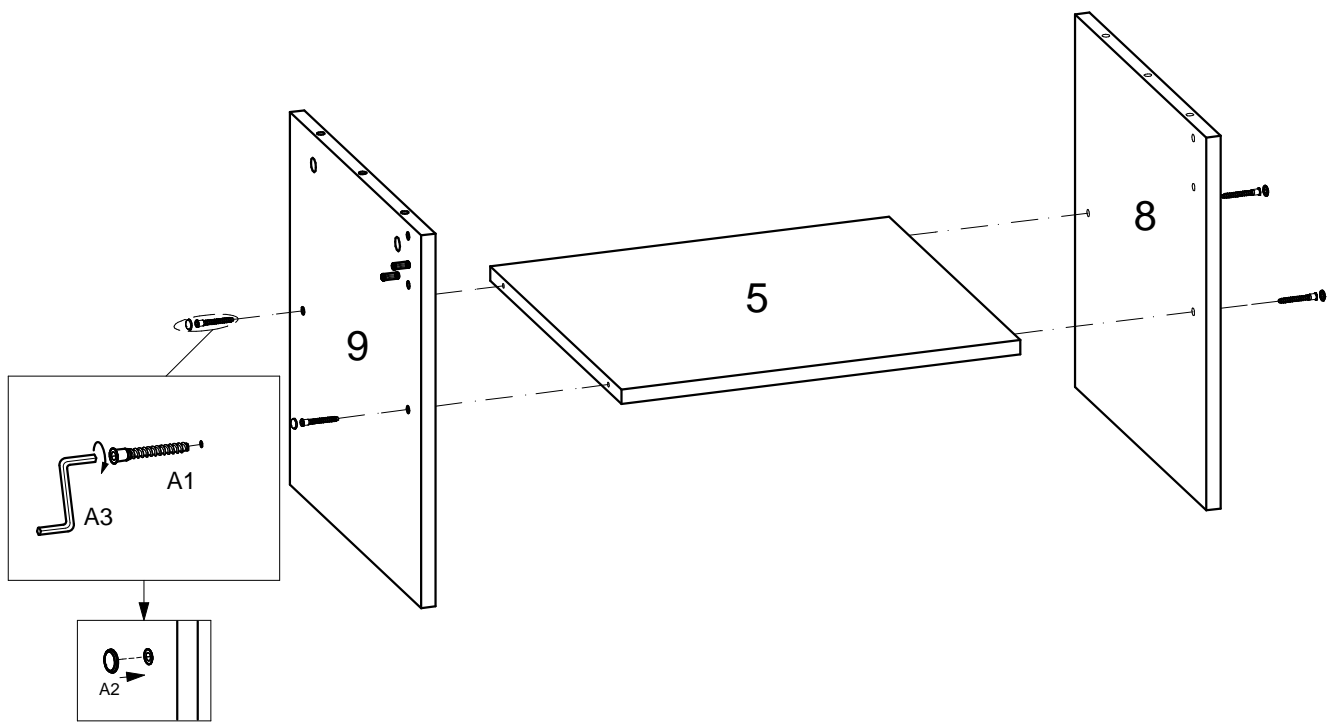
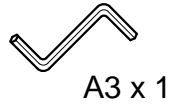
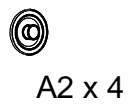
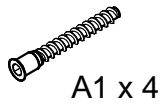

9

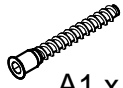

A1 x 4



A2 x 4



A3 x 1

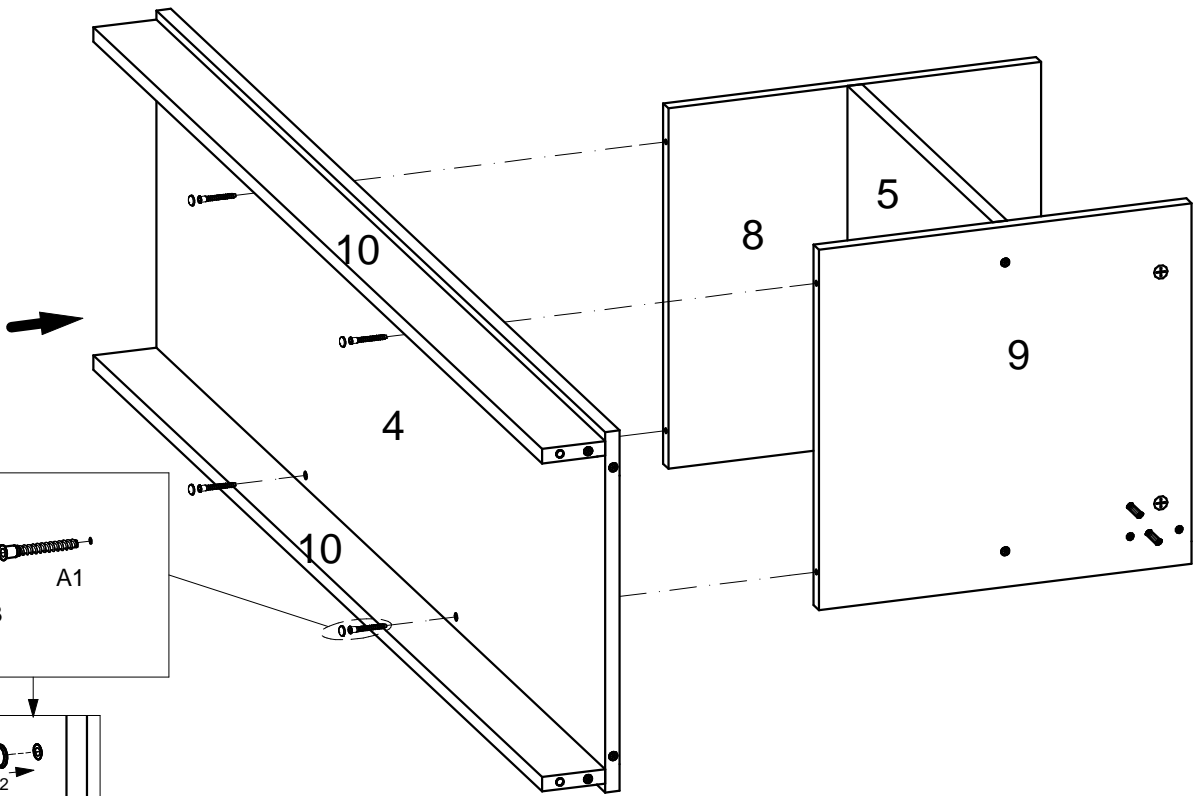

10

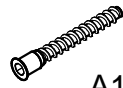

A1 x 16



A2 x 16



A3 x 1

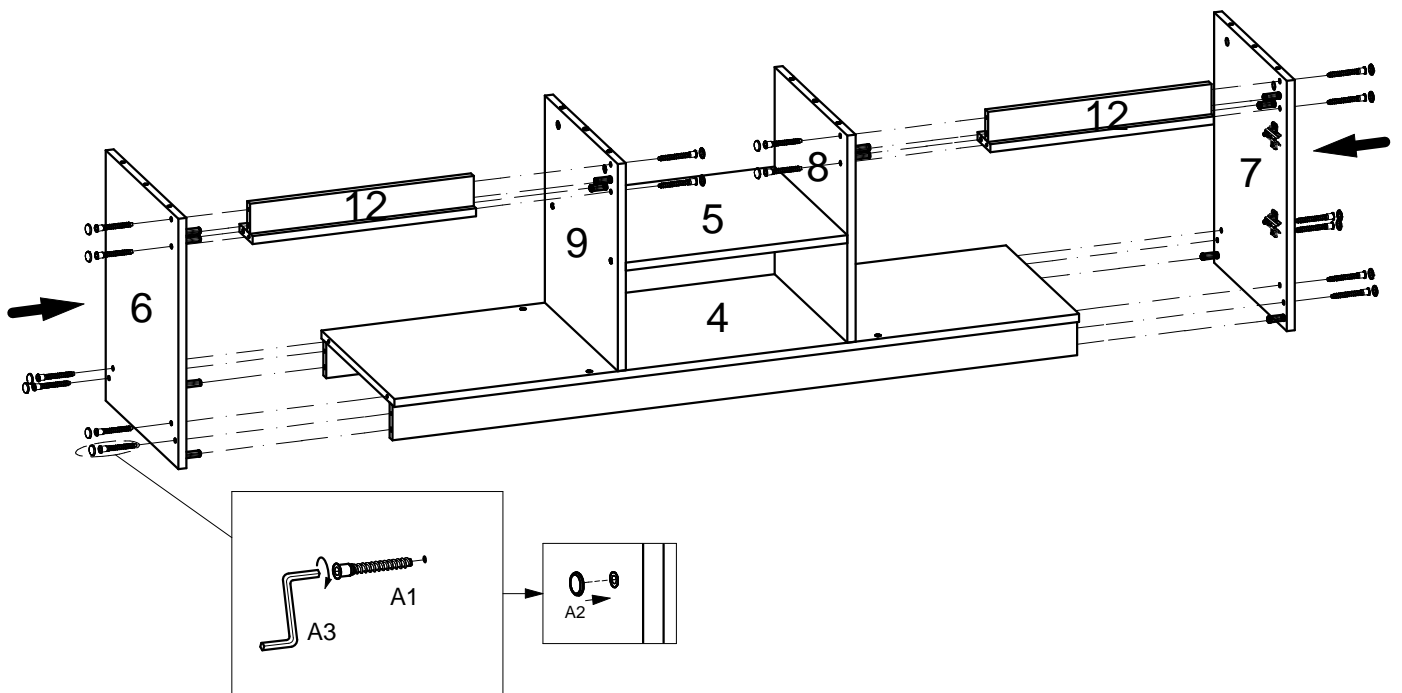
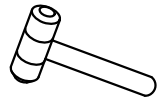

11



B3 x 8

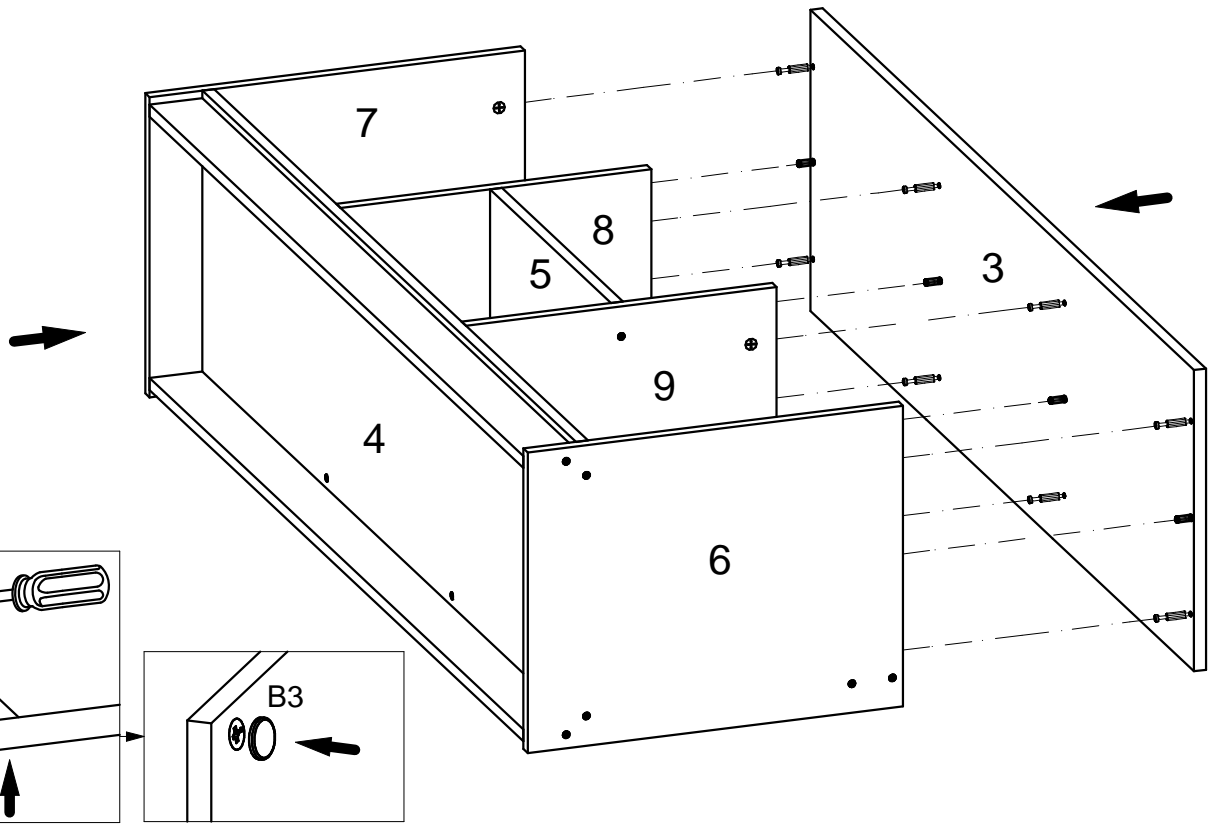
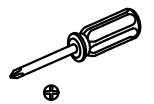
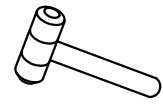

12



D2 x 8

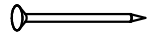

F x 76



N x 8



C x 8

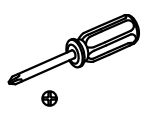
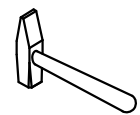

$XX=YY\cong 90^\circ$

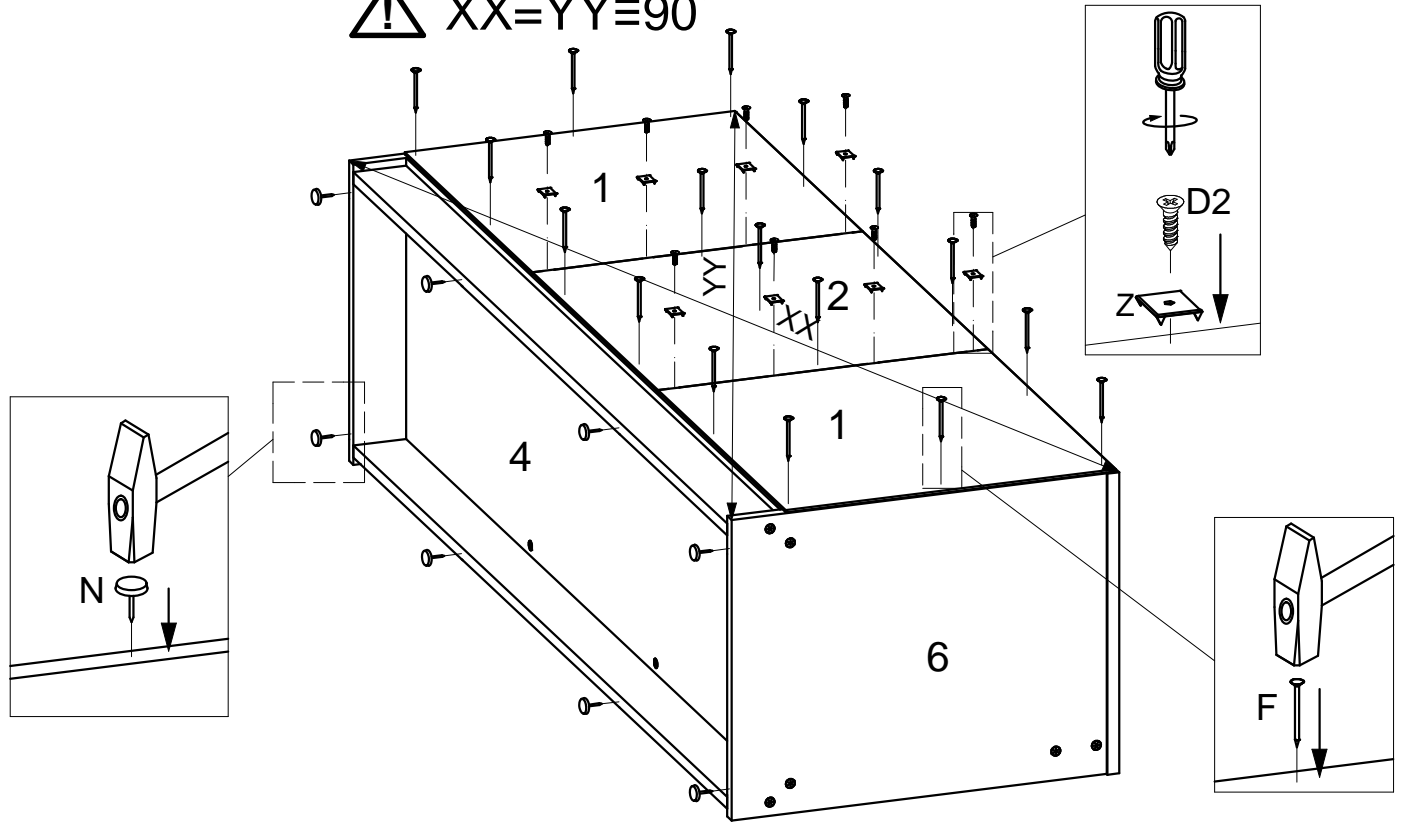

13



D1 x 8

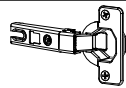

M.2 x 4

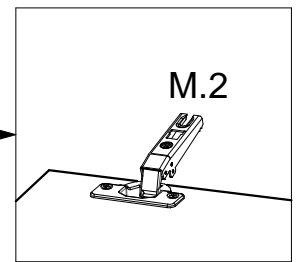
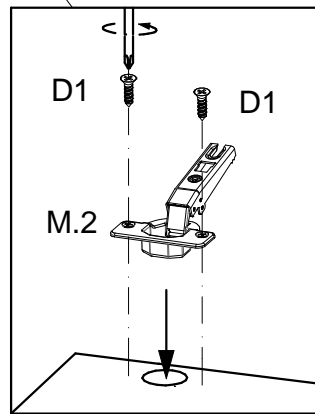
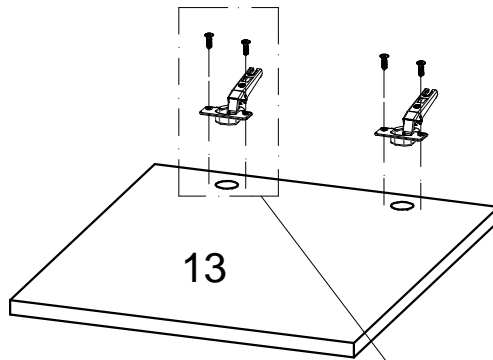
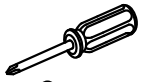

x 2

14

